



TAI-SAW TECHNOLOGY CO., LTD.

No. 3, Industrial 2nd Rd., Ping-Chen Industrial District,
Taoyuan, 324, Taiwan, R.O.C.

TEL: 886-3-4690038 FAX: 886-3-4697532

E-mail: tstsales@mail.taisaw.com Web: www.taisaw.com

Product Specifications Approval Sheet

Product Description: SAW DPX 1950/2140 MHz LTE Band 1 SMD1.8X1.4 mm (BW=60 MHz)

TST Part No.: TF0126C

Customer Part No.: _____

Customer signature required
Company: _____
Division: _____
Approved by : _____
Date: _____

Checked by: _____ Anne Chen 

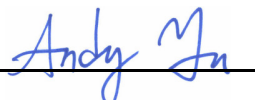
Approved by: _____ Andy Yu 

Date: _____ 04/01/2020

1. Customer signed back is required before TST can proceed with sample build and receive orders.
2. Orders received without customer signed back will be regarded as agreement on the specifications.
3. Any specifications changes must be approved upon by both parties and a new revision of specifications shall be released to reflect the change



TAI-SAW TECHNOLOGY CO., LTD.

No. 3, Industrial 2nd Rd., Ping-Chen Industrial District,
Taoyuan, 324, Taiwan, R.O.C.

TEL: 886-3-4690038 FAX: 886-3-4697532

E-mail: tstsales@mail.taisaw.com Web: www.taisaw.com

SAW DPX 1950/2140 MHz LTE Band 1 SMD 1.8X1.4 mm (BW=60 MHz)

MODEL NO.:TF0126C

REV.1.0

A. MAXIMUM RATING:

1. Operating temperature range: -40 °C to +85 °C
2. Storage temperature range: -40 °C to +85 °C
3. Input power : 29dBm (0.8W)(Ta=+50 °C,>50000h,CW)
4. Maximum DC Voltage: +/-3 V
5. Moisture Sensitivity Level: Level 1
- 6.ESD 50V(MM) 100V(HBM)

RoHS Compliant

Lead-free soldering

Electrostatic Sensitive Device (ESD)

B. ELECTRICAL CHARACTERISTICS:

Terminating impedance (Tx Port): 50//22nH Ω(Single-ended)

Terminating impedance (Rx Port): 100//8.2nH Ω (Balanced)

Terminating impedance (Ant Port): 50//2.7nH Ω (Single-ended)

Tx to ANT (f_{T0}=1950 MHz)

Parameters Description		Unit	Min	Typ	Max	Remarks
Insertion Loss	1920~1980MHz	dB(*1)	-	1.7	2.8	
Amplitude ripple	1920~1980MHz	dB	-	0.8	1.3	
VSWR	ANT	-	-	1.6	2.6	
	Tx	-	-	1.4	2.7	
Attenuation:						
1574~1577 MHz		dB	32	39		
1805~1880 MHz		dB	15	40		
2010~2025 MHz		dB	10	26		Ta=+15~85 °C
2110~2170 MHz		dB	32	49		
2400~2500 MHz		dB	30	50		
3840~3960 MHz		dB	25	38		

ANT to Rx ($f_{T0}=2140$ MHz)

Parameters Description		Unit	Min	Typ	Max	Remarks
Insertion Loss	2110~2170 MHz	dB(*1)	-	1.8	3.2	
Amplitude ripple	2110~2170 MHz	dB	-	0.7	1.3	
Phase balance	2110~2170 MHz	Deg	-12	-8/+1	+12	
Amplitude balance	2110~2170 MHz	dB	-1.2	-0.2/+0.7	+1.2	
VSWR	ANT	-		1.4	2.7	
	Rx			1.7	2.8	

Attenuation:

1920~1980 MHz	dB	35	49	-	
1980~2025 MHz	dB	20	41	-	
2400~2500 MHz	dB	30	40		

Tx to Rx

Isolation	1920~1980MHz	dB	42	57	-	
	2110~2170MHz	dB	31	51	-	

(*1) Specification of insertion loss excludes loss that comes from the test board

C.Evaluation Circuit

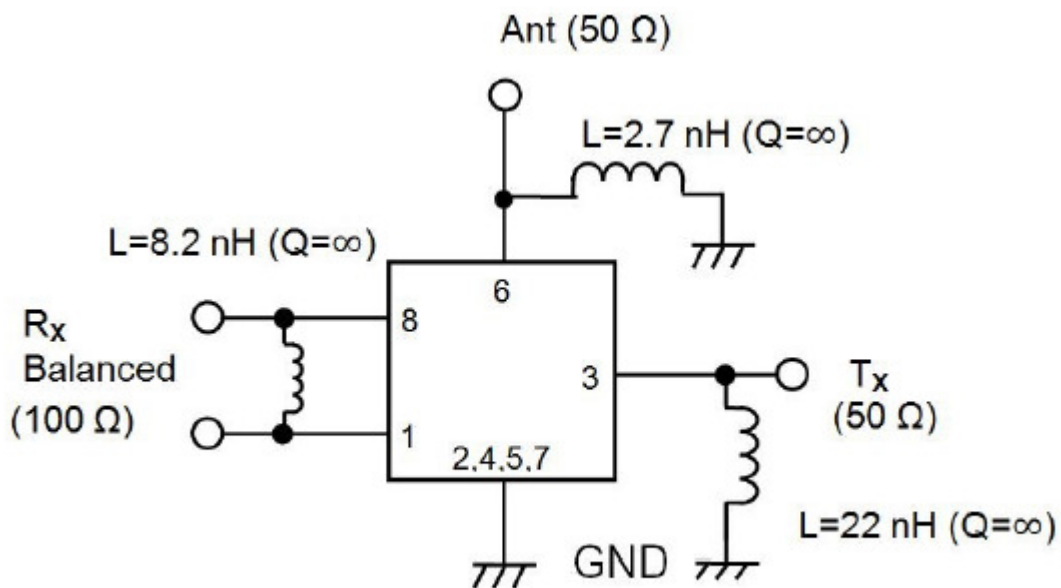

1 to 8: Pin No.

D. FREQUENCY CHARACTERISTICS:

Tx to Ant

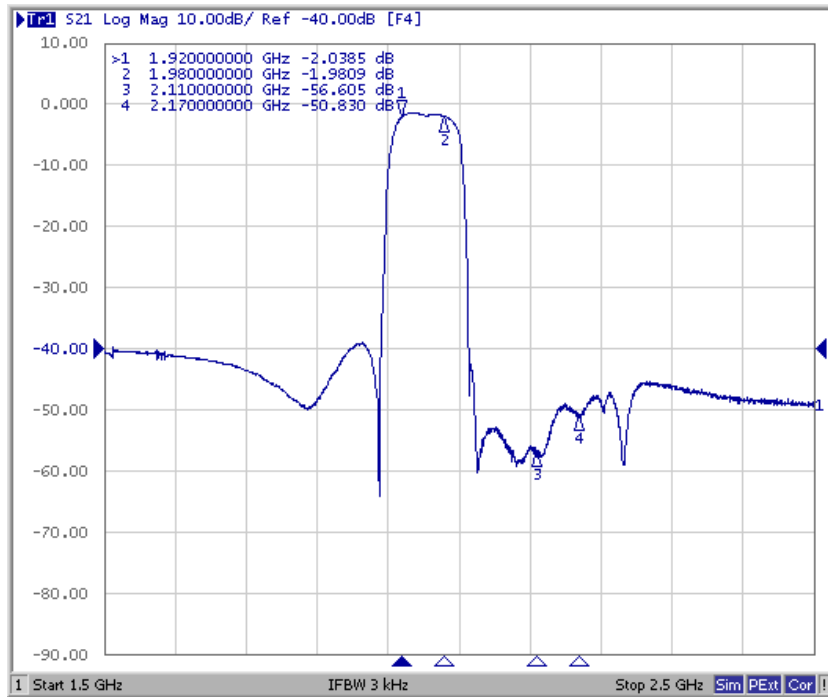

Ant to Rx

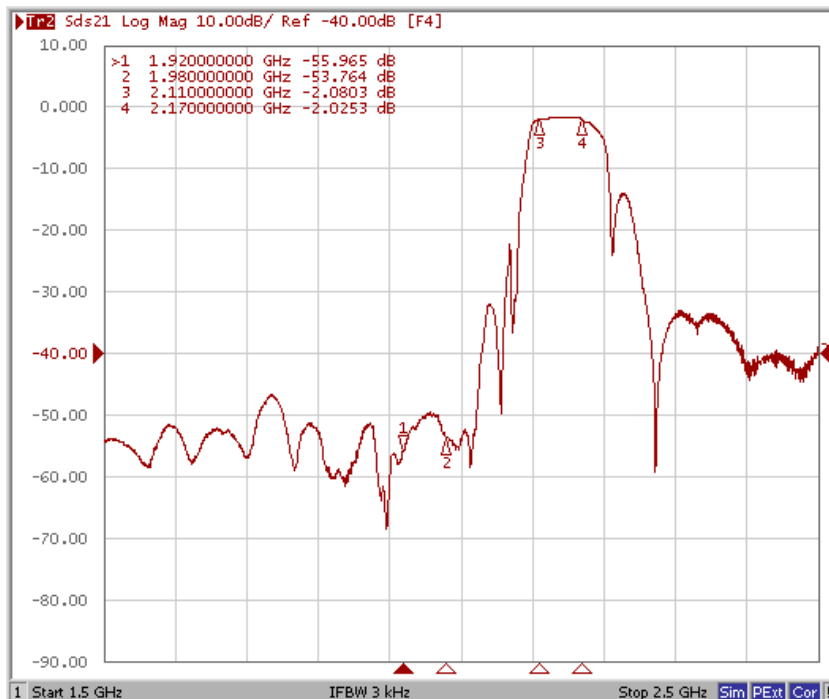

These data exclude loss that comes from the test board.

Tx to Ant ,Ant to Rx

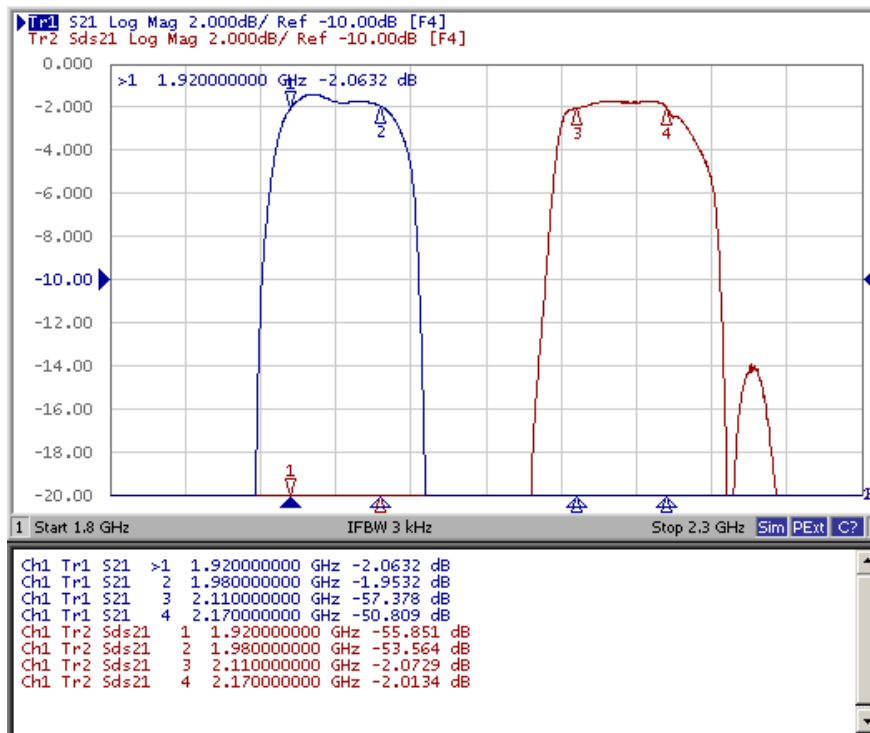

Tx to Rx Isolation

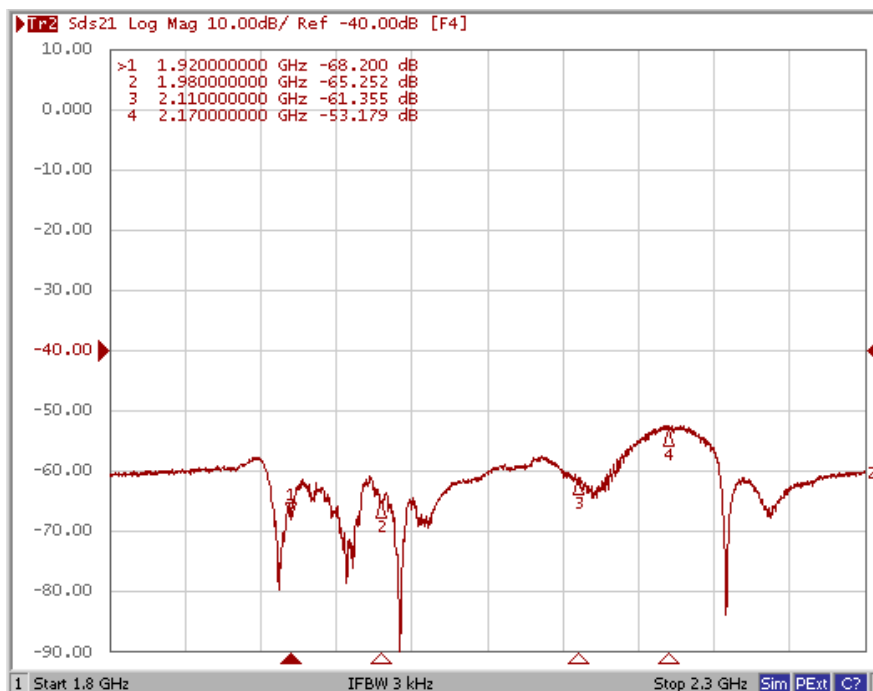

These data exclude loss that comes from the test board.

Tx Port

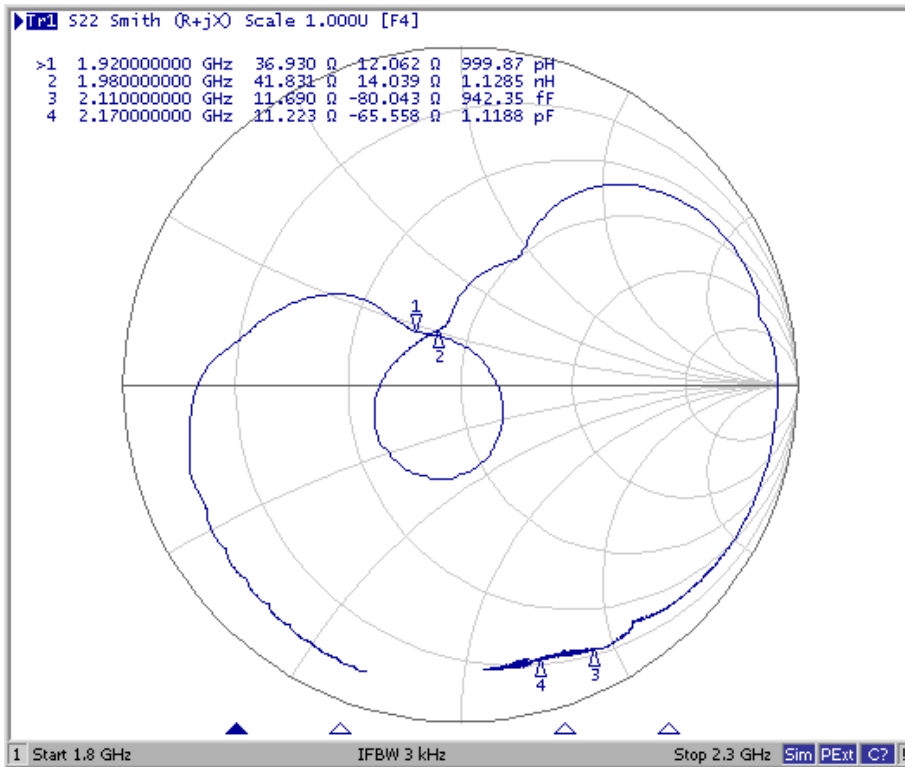
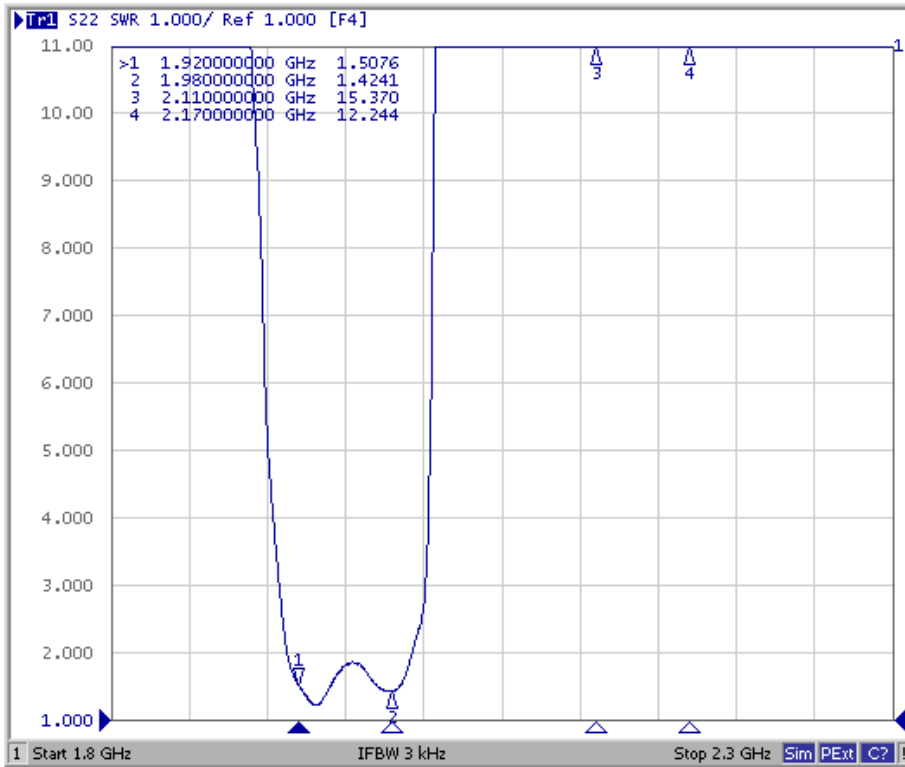

Rx Port

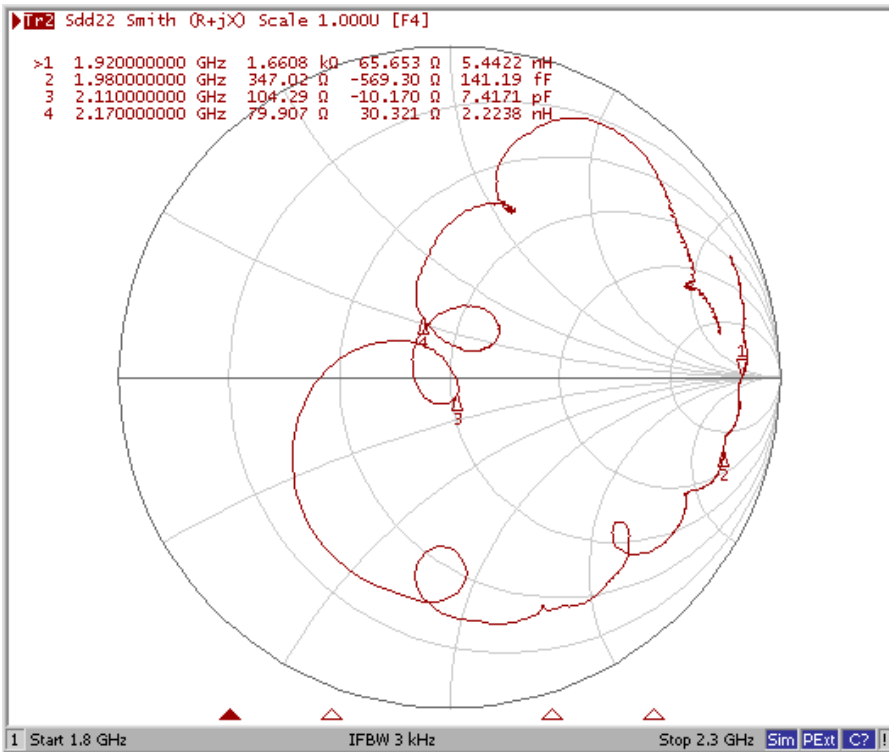
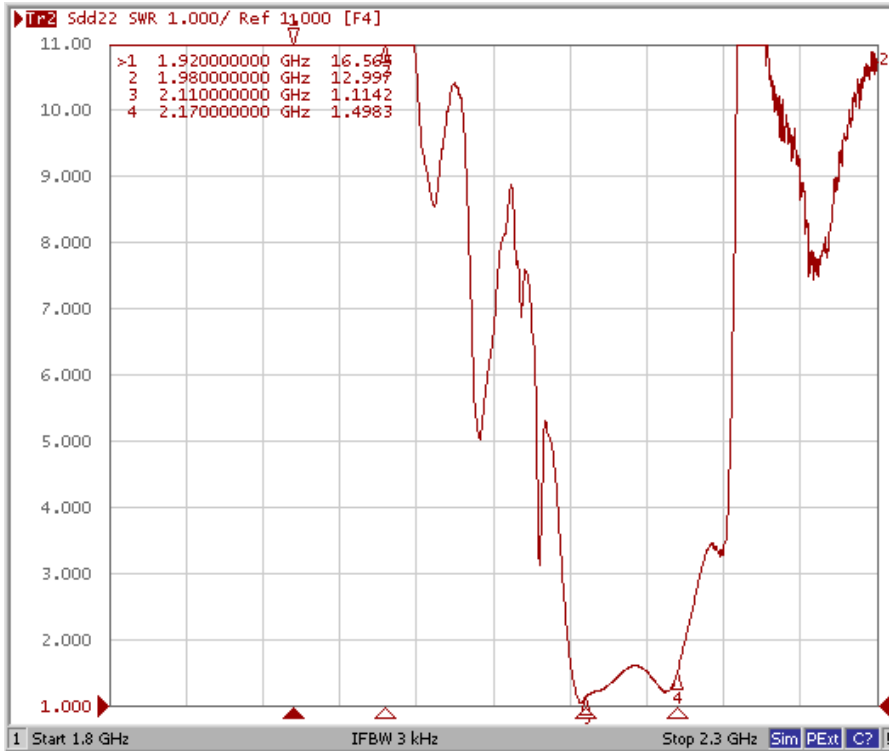

Ant Port

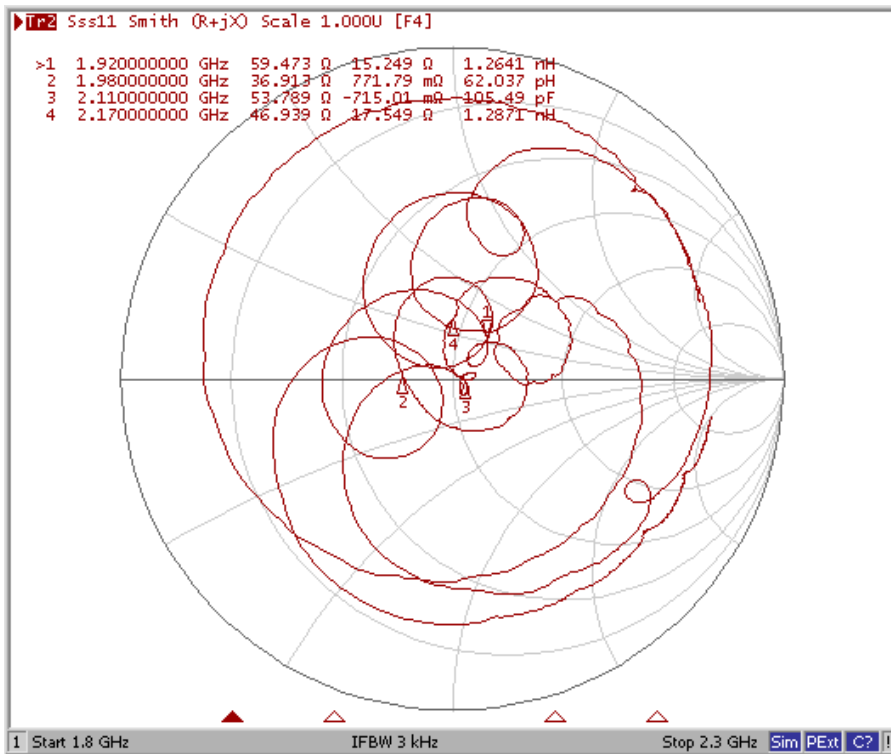
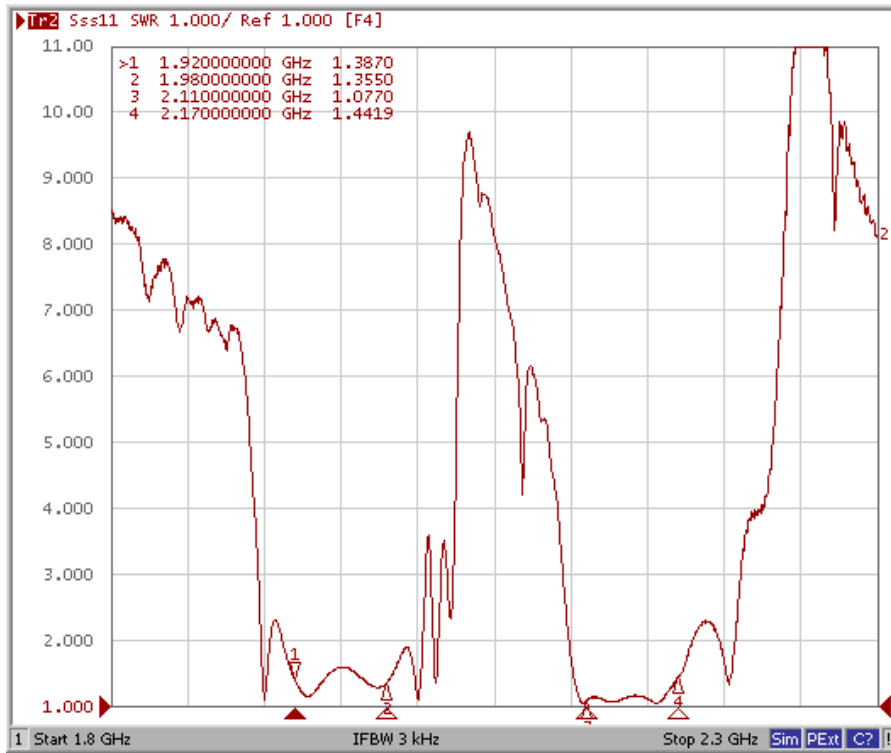

Ant to Rx (Amplitude balance)

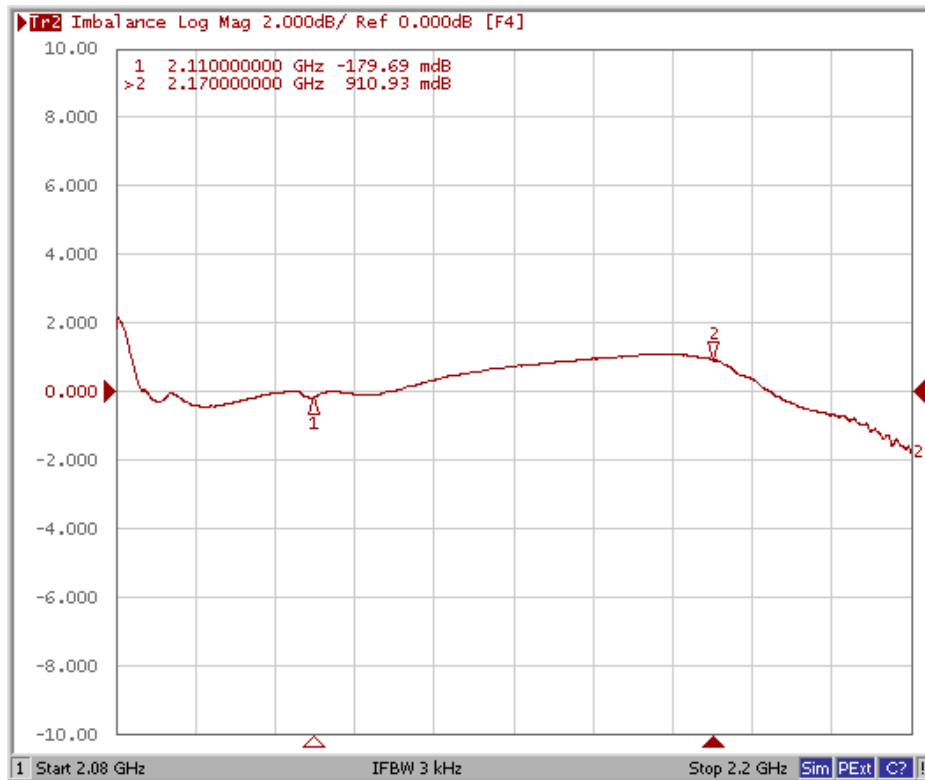

Ant to Rx (Phase balance)

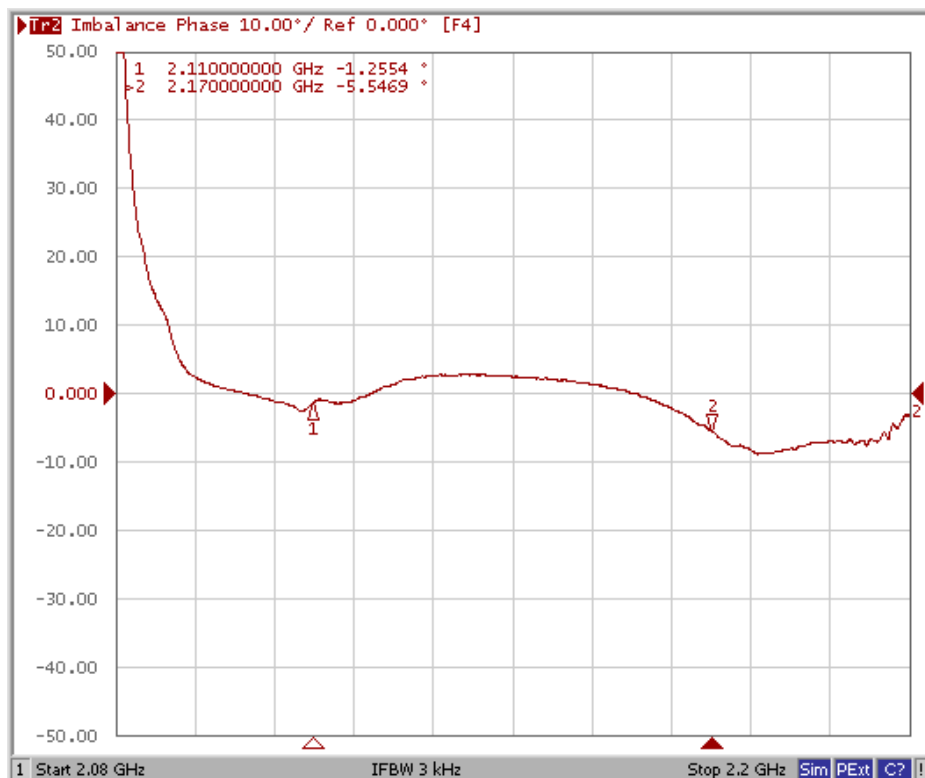

Tx to Ant (Wide span)

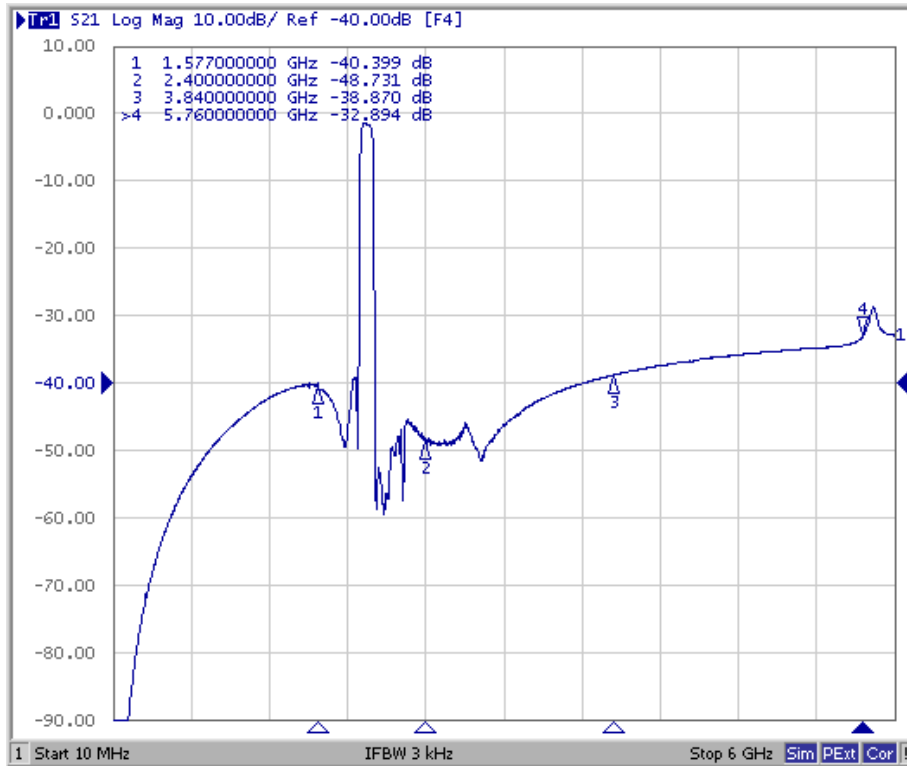

Ant to Rx (Wide span)

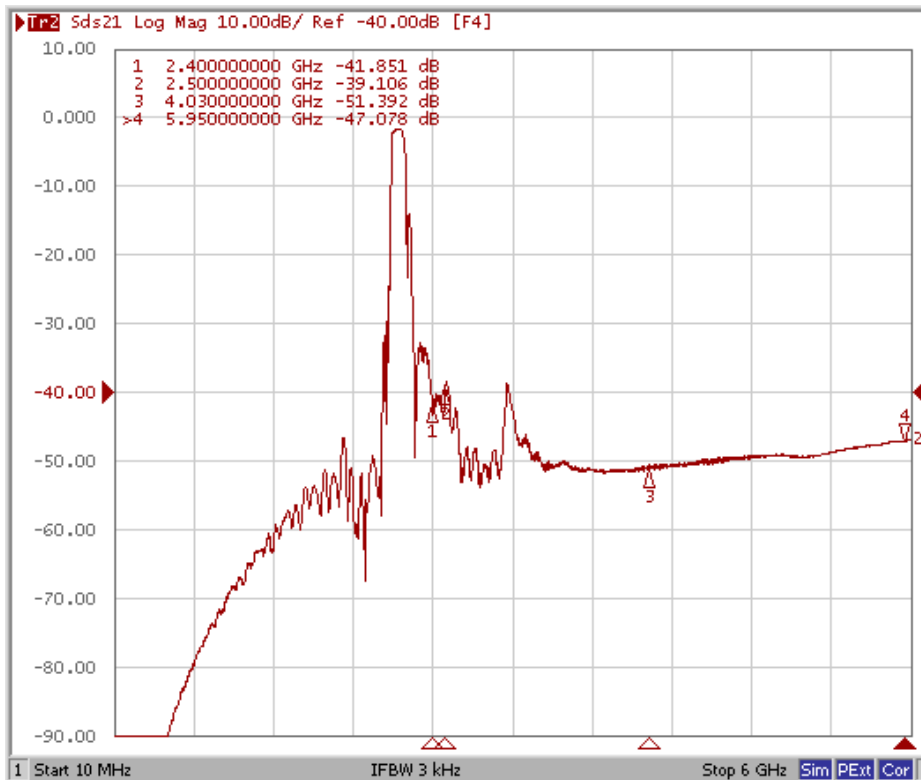

E. OUTLINE DRAWIN:

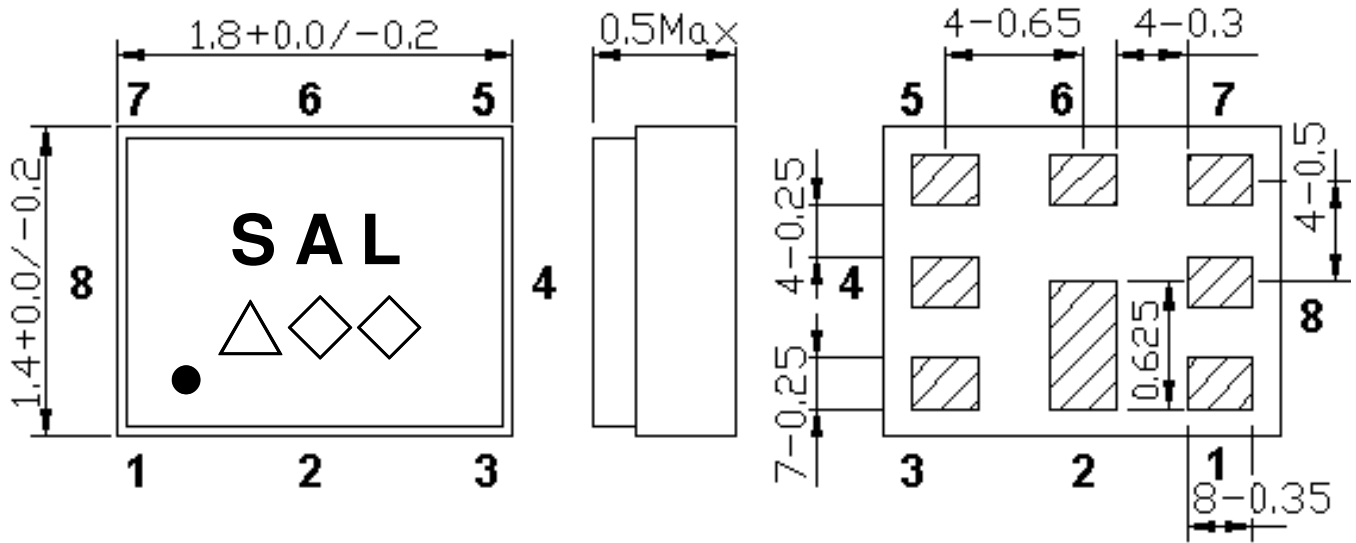

Not Specified Tolerance : +/-0.05 mm

Coplanarity : 0.1 mm max.

1 to 8 : Pin No.

Unit : mm

Marking name : SAL

△: Date code(2019 Dec→m ,....., 2020 May → s.)

◇◇: Lot Code.

Product Date Code. Follow below table.

Year	Jan	Feb	Mar	Apr	May	Jun	Jul	Aug	Sep	Oct	Nov	Dec
2019 / 2023	a	b	c	d	e	f	g	h	j	k	l	m
2020 / 2024	n	p	q	r	s	t	u	v	w	x	y	z
2021 / 2025	A	B	C	Ð	E	IF	G	H	J	K	L	M
2022 / 2026	N	P	Q	R	S	T	U	V	W	X	Y	Z

Pin Configuration

Pin No.	Pin name	Description
1	Rx	Receiver Pin (balanced)
2	GND	Ground Pin
3	Tx	Transmitter Pin
4	GND	Ground Pin
5	GND	Ground Pin
6	ANT	Antenna Pin
7	GND	Ground Pin
8	Rx	Receiver Pin (balanced)

Figure 1. Dimensions and Pin assignment

F. FOOTPRINT:

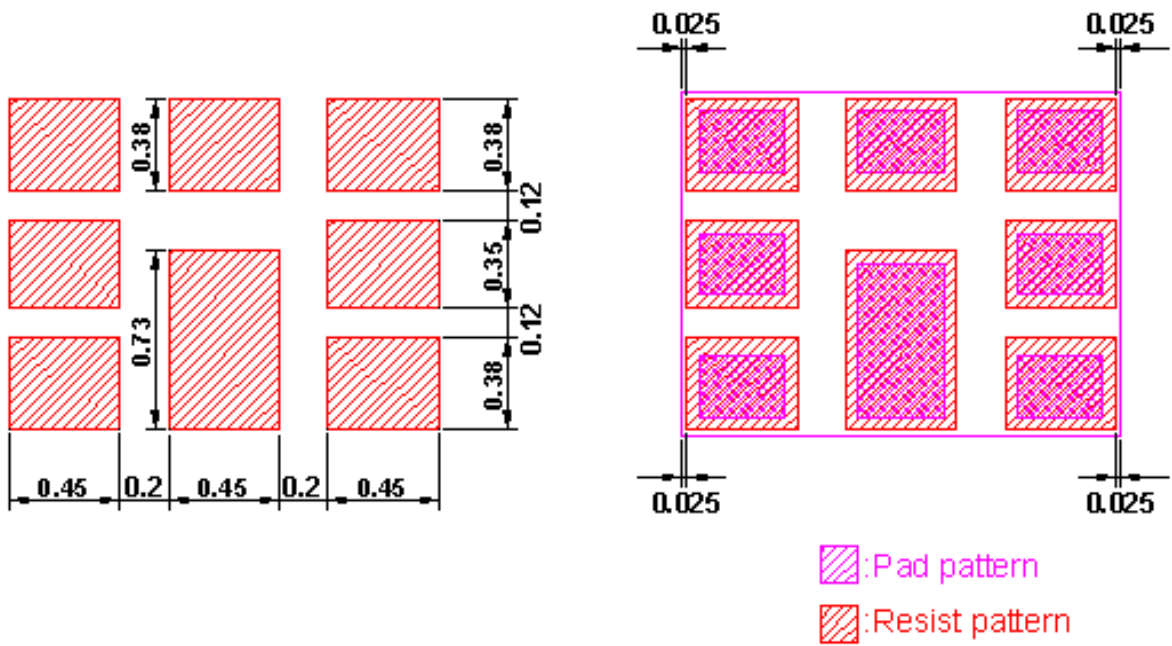

G. PACKING:

1. REEL DIMENSION

(Please refer to FR-75D10 for packing quantity)

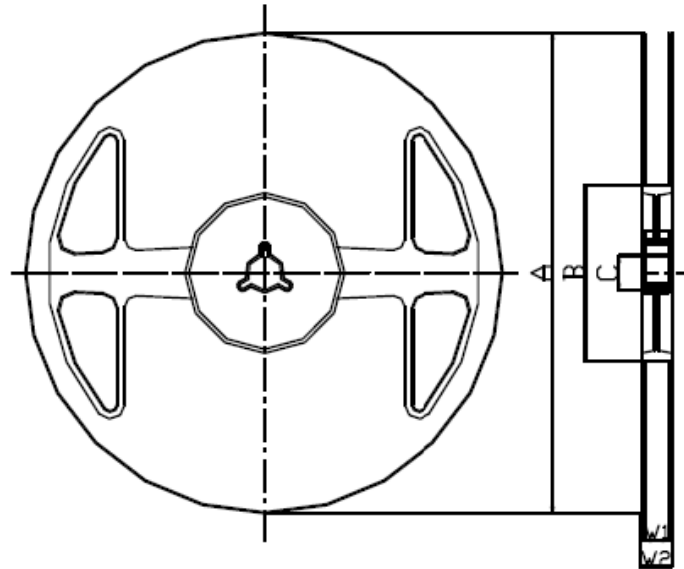

Materials of Reel

Material : Polystyrene + Carbon

Characteristics : Conforms to EIAJ-ET-7200A

Color : Black

Surface resistance (reference value) : $10^9\Omega/\text{sq}$ Max.

Unit : mm

Code	Quantity	A	B	C	W1	W2
Z	3,000 pcs	$\phi 180.0 +0.0/-1.5$	$\phi 66.0 +/-0.5$	$\phi 13.0 +/-0.2$	$9.0 +1.0/-0.0$	$11.4 +/-1.0$

2. TAPE DIMENSION

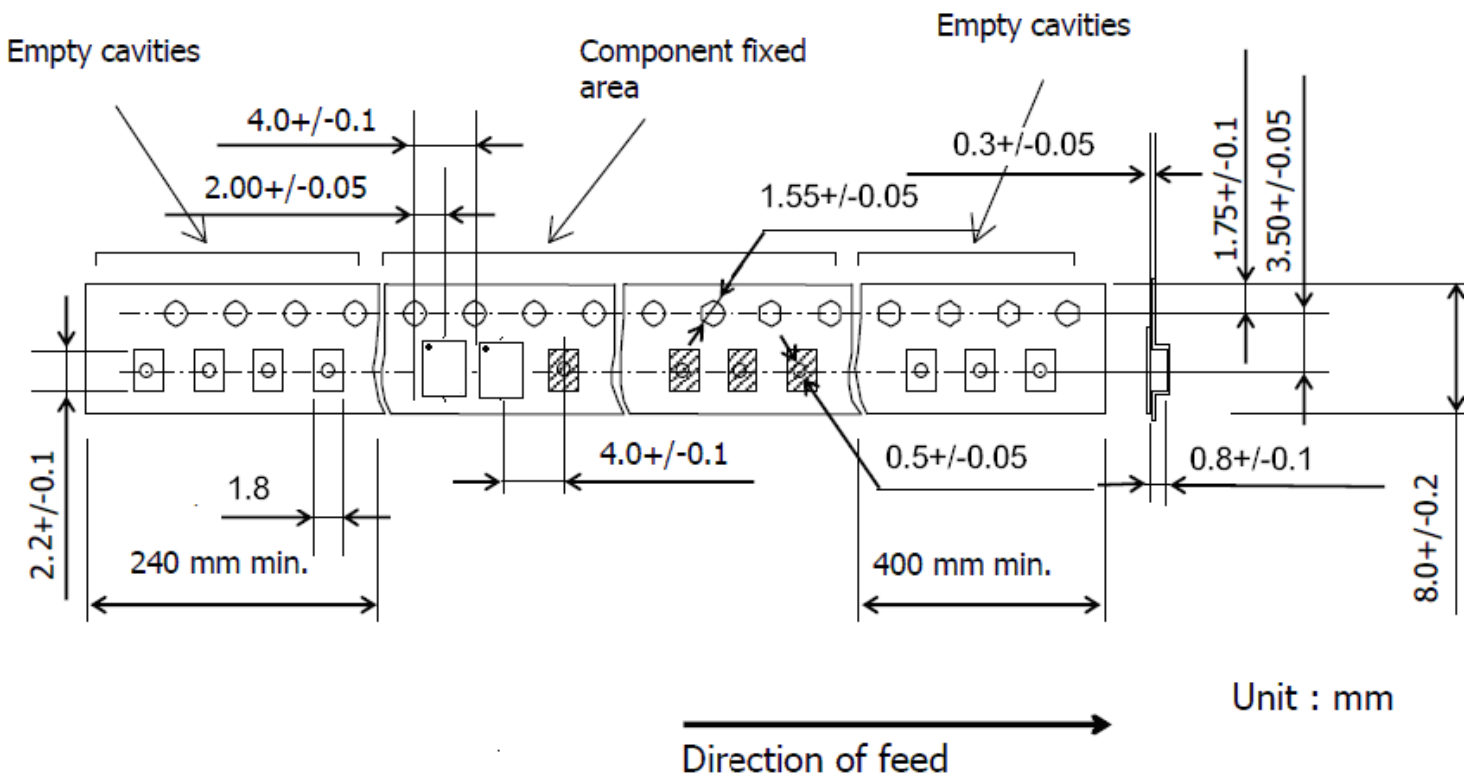

Unit : mm

Direction of feed

H. RECOMMENDED REFLOW PROFILE :

1. Preheating shall be fixed at 150~180°C for 60~90 seconds.
2. Ascending time to preheating temperature 150°C shall be 30 seconds min.
3. Heating shall be fixed at 220°C for 50~80 seconds and at 245~260°C peak (min. 10sec).
4. Time : 2 times.

